

# CUP E

- Halbeinbauleuchte aus Aluminiumdruckguß
- Philips Chip Fortimo SLM Gen.7
- Pulverbeschichtet in weiß, schwarz, silber sowie RAL auf Anfrage
- Hocheffiziente Reflektoren aus 99,9 % Reinstaluminium wahlweise in 16, 24, 36 oder 60°
- Bajonettfrontring mit klarem Schutzglas für werkzeuglosen Reflektorwechsel, das Schutzglas schützt Chip und Reflektor vor Verunreinigungen
- Inkl. Standardtreiber, dimmbarer Treiber auf Anfrage
- PASSIVE Kühlung
- 350° dreh- und 90° schwenkbar
- Gewicht NUR 0,70 kg

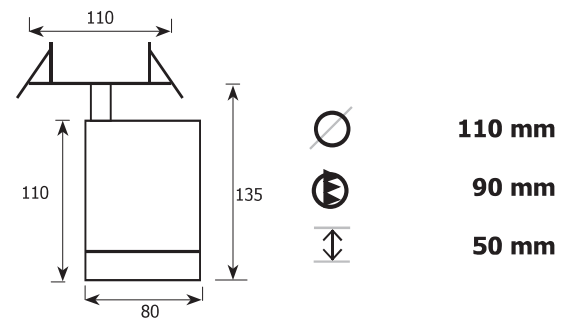

- Recessed luminaire made out of aluminium-diecast
- Philips Chip Fortimo SLM Gen.7
- Powderpainted in white, black, silver or in RAL upon demand
- High efficient reflectors out of extrapure aluminium 99,9 % optionally with beamangle 16, 24, 36 or 60°, dimmable version upon demand
- Twist & look frontring for change of glass & reflectors without any tools, the clear glass protects chip & reflector from dust & dirt
- Incl. standard driver, dimmable version upon demand
- PASSIVE cooling
- 350° turnable and 90° adjustable
- Weight 0,70 kg ONLY!



**IP 20**
220 - 240 V  
50 - 60 Hz



RAL 9006  
silber/  
silver



RAL 9005  
schwarz/  
black



RAL 9016  
weiß/  
white

## Fortimo SLM Gen.7 LES 19mm 11,2-23,1 W

830	3.000 K	RA 80	1.990 - 3.710 Lumen
835	3.500 K	RA 80	1.910 - 3.700 Lumen
840	4.000 K	RA 80	2.130 - 4.110 Lumen
927	2.700 K	RA 90	1.630 - 3.150 Lumen
930	3.000 K	RA 90	1.710 - 3.290 Lumen
935	3.500 K	RA 90	1.780 - 3.440 Lumen
940	4.000 K	RA 90	1.840 - 3.550 Lumen

## Fortimo SLM Gen.7 FOOD LES 19mm 11,2-23,1 W WARM WHITE

925	2.700 K	RA 90	1.130 - 2.170 Lumen
-----	---------	-------	---------------------

## Fortimo SLM Gen.7 FOOD LES 19mm 11,2-23,1 W PREMIUM RED

930	2.900 K	RA 87	1.180 - 2.250 Lumen
-----	---------	-------	---------------------



**1142**

16° 1142-\_-16

24° 1142-\_-24

36° 1142-\_-36

60° 1142-\_-60

# UNIT E

- Halbeinbauleuchte aus Aluminiumdruckguß
- Philips Chip Fortimo SLM Gen.7
- Pulverbeschichtet in weiß, schwarz, silber sowie RAL auf Anfrage
- Hocheffiziente Reflektoren aus 99,9 % Reinstaluminium wahlweise in 16, 24, 36 oder 60°
- Bajonettfrontring mit klarem Schutzglas für werkzeuglosen Reflektorwechsel, das Schutzglas schützt Chip und Reflektor vor Verunreinigungen
- Inkl. Standardtreiber, dimmbarer Treiber auf Anfrage
- PASSIVE Kühlung
- 350° dreh- und 90° schwenkbar
- Gewicht NUR 1,10 kg

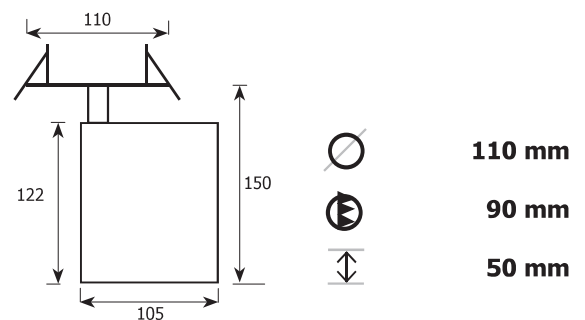

- Recessed LED-luminaire made out of aluminium-diecast
- Philips Chip Fortimo SLM Gen.7
- Powderpainted in white, black, silver or in RAL upon demand
- High efficient reflectors out of extrapure aluminium 99,9 % optionally with beamangle 16, 24, 36 or 60°
- Twist & look frontring for change of glass & reflectors without any tools, the clear glass protects chip & reflector from dust & dirt
- Incl. standard driver, dimmable version upon demand
- PASSIVE cooling
- 350° turnable and 90° adjustable
- Weight 1,10 kg ONLY!

**IP 20**
220 - 240 V  
50 - 60 Hz



1  
RAL 9006  
silber/  
silver



2  
RAL 9005  
schwarz/  
black



3  
RAL 9016  
weiß/  
white

## Fortimo SLM Gen.7 LES 19mm 11,2-30,2 W

830	3.000 K	RA 80	1.990 - 4.610 Lumen
835	3.500 K	RA 80	1.910 - 4.620 Lumen
840	4.000 K	RA 80	2.130 - 5.150 Lumen
927	2.700 K	RA 90	1.630 - 3.940 Lumen
930	3.000 K	RA 90	1.710 - 4.130 Lumen
935	3.500 K	RA 90	1.780 - 4.310 Lumen
940	4.000 K	RA 90	1.840 - 4.450 Lumen

## Fortimo SLM Gen.7 FOOD LES 19mm 11,2-30,2 W WARM WHITE

925	2.700 K	RA 90	1.130 - 2.710 Lumen
-----	---------	-------	---------------------

## Fortimo SLM Gen.7 FOOD LES 19mm 11,2-30,2 W PREMIUM RED

930	2.900 K	RA 87	1.180 - 2.820 Lumen
-----	---------	-------	---------------------



**1122**

16° 1122-\_-16

24° 1122-\_-24

36° 1122-\_-36

60° 1122-\_-60

# DOWN 174

- LED-Einbauleuchte starr
- Philips Chip Fortimo SLM Gen.7
- Material Aluminiumdruckguss
- Pulverbeschichtet in weiß, schwarz, silber sowie RAL auf Anfrage
- Hocheffizienter Reflektor aus 99,9 % Reinstaluminium in 60°
- klares Schutzglas zum Schutz des Reflektors vor Verunreinigungen
- Inkl. Standardtreiber, dimmbare Treiber auf Anfrage
- PASSIVE Kühlung
- Gewicht NUR 0,75 kg

- Fix recessed LED-luminaire
- Philips Chip Fortimo SLM Gen.7
- Material diecast-aluminium
- Powderpainted in white, black, silver or in RAL upon demand
- High efficient reflectors out of extrapure aluminium 99,9 % in 60°
- Clear protection glass to protect chip & reflector from dust & dirt
- Incl. standard driver, dimmable driver upon demand
- PASSIVE cooling
- Weight 0,75 kg ONLY!

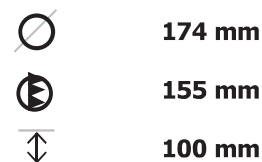



**CE IP 20**
220 - 240 V  
50 - 60 Hz



RAL 9006  
silber/  
silver



RAL 9005  
schwarz/  
black



RAL 9016  
weiß/  
white

## Fortimo SLM Gen.7 LES 19mm 11,2-30,2 W

830	3.000 K	RA 80	1.990 - 4.610 Lumen
835	3.500 K	RA 80	1.910 - 4.620 Lumen
840	4.000 K	RA 80	2.130 - 5.150 Lumen
927	2.700 K	RA 90	1.630 - 3.940 Lumen
930	3.000 K	RA 90	1.710 - 4.130 Lumen
935	3.500 K	RA 90	1.780 - 4.310 Lumen
940	4.000 K	RA 90	1.840 - 4.450 Lumen

## Fortimo SLM Gen.7 FOOD LES 19mm 11,2-30,2 W WARM WHITE

925	2.700 K	RA 90	1.130 - 2.710 Lumen
-----	---------	-------	---------------------

## Fortimo SLM Gen.7 FOOD LES 19mm 11,2-30,2 W PREMIUM RED

930	2.900 K	RA 87	1.180 - 2.820 Lumen
-----	---------	-------	---------------------



60°

**3032**

3032-\_-60

# DOWN 230

- LED-Einbauleuchte starr
  - Philips Chip Fortimo SLM Gen.7
  - Material Aluminiumdruckguss
  - Pulverbeschichtet in weiß, schwarz, silber sowie RAL auf Anfrage
  - Hocheffizienter Reflektor aus 99,9 % Reinstaluminium in 60°
  - klares Schutzglas zum Schutz des Reflektors vor Verunreinigungen
  - Inkl. Standardtreiber, dimmbare Treiber auf Anfrage
  - PASSIVE Kühlung
  - Gewicht NUR 1,25 kg
- 
- Fix recessed LED-luminaire
  - Philips Chip Fortimo SLM Gen.7
  - Material diecast-aluminium
  - Powderpainted in white, black, silver or in RAL upon demand
  - High efficient reflectors out of extrapure aluminium 99,9 % in 60°
  - Clear protection glass to protect chip & reflector from dust & dirt
  - Incl. standard driver, dimmable driver upon demand
  - PASSIVE cooling
  - Weight 1,25 kg ONLY!

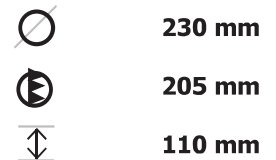



**CE IP 20**
220 - 240 V  
50 - 60 Hz



1  
RAL 9006  
silber/  
silver



2  
RAL 9005  
schwarz/  
black



3  
RAL 9016  
weiß/  
white

## Fortimo SLM Gen.7 LES 19mm 11,2-41,7 W

830	3.000 K	RA 80	1.990 - 5.870 Lumen
835	3.500 K	RA 80	1.910 - 5.880 Lumen
840	4.000 K	RA 80	2.130 - 6.620 Lumen
927	2.700 K	RA 90	1.630 - 5.060 Lumen
930	3.000 K	RA 90	1.710 - 5.300 Lumen
935	3.500 K	RA 90	1.780 - 5.530 Lumen
940	4.000 K	RA 90	1.840 - 5.710 Lumen

## Fortimo SLM Gen.7 FOOD LES 19mm 11,2-41,7 W WARM WHITE

925	2.700 K	RA 90	1.130 - 3.460 Lumen
-----	---------	-------	---------------------

## Fortimo SLM Gen.7 FOOD LES 19mm 11,2-41,7 W PREMIUM RED

930	2.900 K	RA 87	1.180 - 3.610 Lumen
-----	---------	-------	---------------------



60°

**3042**

3042-\_-60

# WALL

- LED-Einbauleuchte 60° ausschwenkbar
- Philips Chip Fortimo SLM Gen.7
- Material Aluminiumdruckguss
- Pulverbeschichtet in weiß, schwarz, silber sowie RAL auf Anfrage
- Hocheffizienter Reflektor aus 99,9 % Reinstaluminium in 78 x 100°
- klares Schutzglas zum Schutz des Reflektors vor Verunreinigungen
- Inkl. Standardtreiber, dimmbare Treiber auf Anfrage
- PASSIVE Kühlung
- Gewicht NUR 1,39 kg

- Recessed LED-luminaire 60° adjustable
- Philips Chip Fortimo SLM Gen.7
- Material diecast-aluminium
- Powderpainted in white, black, silver or in RAL upon demand
- High efficient reflectors out of extrapure aluminium 99,9 % in 78 x 100°
- Clear protection glass to protect chip & reflector from dust & dirt
- Incl. standard driver, dimmable driver upon demand
- PASSIVE cooling
- Weight 1,39 kg ONLY!

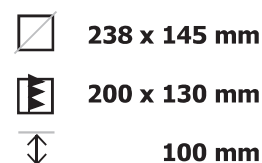

**CE IP 20**
220 - 240 V  
50 - 60 Hz



RAL 9006  
silber/  
silver



RAL 9005  
schwarz/  
black



RAL 9016  
weiß/  
white

## Fortimo SLM Gen.7 LES 19mm 11,2-30,2 W

830	3.000 K	RA 80	1.990 - 4.610 Lumen
835	3.500 K	RA 80	1.910 - 4.620 Lumen
840	4.000 K	RA 80	2.130 - 5.150 Lumen
927	2.700 K	RA 90	1.630 - 3.940 Lumen
930	3.000 K	RA 90	1.710 - 4.130 Lumen
935	3.500 K	RA 90	1.780 - 4.310 Lumen
940	4.000 K	RA 90	1.840 - 4.450 Lumen

## Fortimo SLM Gen.7 FOOD LES 19mm 11,2-30,2 W WARM WHITE

925	2.700 K	RA 90	1.130 - 2.710 Lumen
-----	---------	-------	---------------------

## Fortimo SLM Gen.7 FOOD LES 19mm 11,2-30,2 W PREMIUM RED

930	2.900 K	RA 87	1.180 - 2.820 Lumen
-----	---------	-------	---------------------



78 x 100° 3012\_

**3012**

# CAYO

- Kardanische LED-Einbauleuchte 2 x 40° schwenkbar
- Philips Chip Fortimo SLM Gen.7
- Material Aluminiumdruckguss
- Pulverbeschichtet in weiß, schwarz, silber sowie RAL auf Anfrage
- Reflektoren aus 99,9 % Reinstaluminium wahlweise 15, 24 oder 36°
- Bajonettfrontring mit klarem Schutzglas für werkzeuglosen Reflektorwechsel, das Schutzglas schützt Chip und Reflektor vor Verunreinigungen
- Passive Kühlung
- Inkl. Standardtreiber, dimmbare Treiber auf Anfrage
- Gewicht: 0,85 kg



- Gimballed recessed LED-luminaire, 2 x 40°
- Philips Chip Fortimo SLM Gen.7
- Material diecast-aluminium
- Powderpainted in white, black, silver as well as RAL upon demand
- Reflectors out of pure aluminium 99,9 % optionally 15, 24 or 36°
- Twist & look frontring for change of glass & reflectors without any tools, the clear glass protects chip & reflector from dust & dirt
- Passive cooling
- Incl. standard driver, dimmable version upon demand
- Weight: 0,85 kg

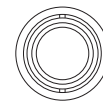

**125 mm**

**117 mm**

**125 mm**



**CE IP 20**

220 - 240 V  
50 - 60 Hz



RAL 9006  
silber/  
silver



RAL 9005  
schwarz/  
black



RAL 9016  
weiß/  
white

## Fortimo SLM Gen.7 LES 19mm 11,2-23,1 W

830	3.000 K	RA 80	1.990 - 3.710 Lumen
835	3.500 K	RA 80	1.910 - 3.700 Lumen
840	4.000 K	RA 80	2.130 - 4.110 Lumen
927	2.700 K	RA 90	1.630 - 3.150 Lumen
930	3.000 K	RA 90	1.710 - 3.290 Lumen
935	3.500 K	RA 90	1.780 - 3.440 Lumen
940	4.000 K	RA 90	1.840 - 3.550 Lumen

## Fortimo SLM Gen.7 FOOD LES 19mm 11,2-23,1 W WARM WHITE

925	2.700 K	RA 90	1.130 - 2.170 Lumen
-----	---------	-------	---------------------

## Fortimo SLM Gen.7 FOOD LES 19mm 11,2-23,1 W PREMIUM RED

930	2.900 K	RA 87	1.180 - 2.250 Lumen
-----	---------	-------	---------------------



**1299**

15° 1299-\_-15

24° 1299-\_-24

36° 1299-\_-36

# MOVE

- LED-Einbauleuchte 350° drehbar und 55° ausschwenkbar
- Philips Chip Fortimo SLM Gen.7
- Material Aluminiumdruckguss
- Pulverbeschichtet in weiß, schwarz, silber sowie RAL auf Anfrage
- Reflektoren aus 99,9 % Reinstaluminium wahlweise 12, 24 oder 36°
- Bajonettfrontring mit klarem Schutzglas für werkzeuglosen Reflektorwechsel, das Schutzglas schützt Chip und Reflektor vor Verunreinigungen
- Passive Kühlung
- Inkl. Standardtreiber, dimmbare Treiber auf Anfrage
- Gewicht: 1,10 kg

- Recessed LED-luminaire 350° turnable and 55° adjustable
- Philips Chip Fortimo SLM Gen.7
- Material diecast-aluminium
- Powderpainted in white, black, silver as well as RAL upon demand
- Reflectors out of pure aluminium 99,9 % optionally 12, 24 or 36°
- Twist & look frontring for change of glass & reflectors without any tools, the clear glass protects chip & reflector from dust & dirt
- Passive cooling
- Incl. standard driver, dimmable version upon demand
- Weight: 1,10 kg

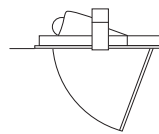

**158 mm**



**145 mm**



**120 mm**



**IP 20**

220 - 240 V  
50 - 60 Hz



RAL 9006  
silber/  
silver



RAL 9005  
schwarz/  
black



RAL 9016  
weiß/  
white

## Fortimo SLM Gen.7 LES 19mm 11,2-30,2 W

830	3.000 K	RA 80	1.990 - 4.610 Lumen
835	3.500 K	RA 80	1.910 - 4.620 Lumen
840	4.000 K	RA 80	2.130 - 5.150 Lumen
927	2.700 K	RA 90	1.630 - 3.940 Lumen
930	3.000 K	RA 90	1.710 - 4.130 Lumen
935	3.500 K	RA 90	1.780 - 4.310 Lumen
940	4.000 K	RA 90	1.840 - 4.450 Lumen

## Fortimo SLM Gen.7 FOOD LES 19mm 11,2-30,2 W WARM WHITE

925	2.700 K	RA 90	1.130 - 2.710 Lumen
-----	---------	-------	---------------------

## Fortimo SLM Gen.7 FOOD LES 19mm 11,2-30,2 W PREMIUM RED

930	2.900 K	RA 87	1.180 - 2.820 Lumen
-----	---------	-------	---------------------



**3218**

12° 3218-\_-12

24° 3218-\_-24

36° 3218-\_-36

# BOXX

- LED-Einbauleuchte 350° drehbar und 2 x 25° schwenkbar
- Philips Chip Fortimo SLM Gen.7
- Material Aluminiumdruckguss
- Pulverbeschichtet in weiß, schwarz, silber sowie RAL auf Anfrage
- Reflektoren aus 99,9 % Reinstaluminium wahlweise 12, 24 oder 36°
- Bajonettfrontring mit klarem Schutzglas für werkzeuglosen Reflektorwechsel, das Schutzglas schützt Chip und Reflektor vor Verunreinigungen
- Passive Kühlung
- Inkl. Standardtreiber, dimmbare Treiber auf Anfrage
- Gewicht: 0,90 kg



- Recessed LED-luminaire 350° turnable and 2 x 25° adjustable
- Philips Chip Fortimo SLM Gen.7
- Material diecast-aluminium
- Powderpainted in white, black, silver as well as RAL upon demand
- Reflectors out of pure aluminium 99,9 % optionally 12, 24 or 36°
- Twist & look frontring for change of glass & reflectors without any tools, the clear glass protects chip & reflector from dust & dirt
- Passive cooling
- Incl. standard driver, dimmable version upon demand
- Weight: 0,90 kg

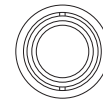

**158 mm**



**145 mm**



**120 mm**

△ □ CE IP 20

220 - 240 V  
50 - 60 Hz



1  
RAL 9006  
silber/  
silver



2  
RAL 9005  
schwarz/  
black



3  
RAL 9016  
weiß/  
white

## Fortimo SLM Gen.7 LES 19mm 11,2-30,2 W

830	3.000 K	RA 80	1.990 - 4.610 Lumen
835	3.500 K	RA 80	1.910 - 4.620 Lumen
840	4.000 K	RA 80	2.130 - 5.150 Lumen
927	2.700 K	RA 90	1.630 - 3.940 Lumen
930	3.000 K	RA 90	1.710 - 4.130 Lumen
935	3.500 K	RA 90	1.780 - 4.310 Lumen
940	4.000 K	RA 90	1.840 - 4.450 Lumen

## Fortimo SLM Gen.7 FOOD LES 19mm 11,2-30,2 W WARM WHITE

925	2.700 K	RA 90	1.130 - 2.710 Lumen
-----	---------	-------	---------------------

## Fortimo SLM Gen.7 FOOD LES 19mm 11,2-30,2 W PREMIUM RED

930	2.900 K	RA 87	1.180 - 2.820 Lumen
-----	---------	-------	---------------------



**3219**

12° 3219-\_-12

24° 3219-\_-24

36° 3219-\_-36



# DOROX

- Kardanische LED-Einbauleuchte 2 x 40° schwenkbar
- Philips Chip Fortimo SLM Gen.7
- Material Aluminiumdruckguss, Einbaurahmen aus Stahlblech
- Pulverbeschichtet in weiß, schwarz, silber sowie RAL auf Anfrage
- Reflektoren aus 99,9 % Reinaluminium wahlweise 14, 24 oder 36°
- Bajonettfrontring mit klarem Schutzglas für werkzeuglosen Reflektorwechsel, das Schutzglas schützt Chip und Reflektor vor Verunreinigungen
- Passive Kühlung
- Inkl. Standardtreiber, dimmbare Treiber auf Anfrage
- Gewicht: 1,25 kg



- Gimballed recessed LED-luminaire, 2 x 40°
- Philips Chip Fortimo SLM Gen.7
- Material diecast-aluminium, frame out of steel
- Powderpainted in white, black, silver as well as RAL upon demand
- Reflectors out of pure aluminium 99,9 % optionally 14, 24 or 36°
- Twist & look frontring for change of glass & reflectors without any tools, the clear glass protects chip & reflector from dust & dirt
- Passive cooling
- Incl. standard driver, dimmable version upon demand
- Weight: 1,25 kg

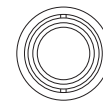

**150 mm**



**140 mm**



**160 mm**



**CE IP 20**

220 - 240 V  
50 - 60 Hz



RAL 9006  
silber/  
silver



RAL 9005  
schwarz/  
black



RAL 9016  
weiß/  
white

## Fortimo SLM Gen.7 LES 19mm 11,2-30,2 W

830	3.000 K	RA 80	1.990 - 4.610 Lumen
835	3.500 K	RA 80	1.910 - 4.620 Lumen
840	4.000 K	RA 80	2.130 - 5.150 Lumen
927	2.700 K	RA 90	1.630 - 3.940 Lumen
930	3.000 K	RA 90	1.710 - 4.130 Lumen
935	3.500 K	RA 90	1.780 - 4.310 Lumen
940	4.000 K	RA 90	1.840 - 4.450 Lumen

## Fortimo SLM Gen.7 FOOD LES 19mm 11,2-30,2 W WARM WHITE

925	2.700 K	RA 90	1.130 - 2.710 Lumen
-----	---------	-------	---------------------

## Fortimo SLM Gen.7 FOOD LES 19mm 11,2-30,2 W PREMIUM RED

930	2.900 K	RA 87	1.180 - 2.820 Lumen
-----	---------	-------	---------------------



**3229**

14° 3229-\_-14

24° 3229-\_-24

36° 3229-\_-36

# DOROX

- Kardanische LED-Einbauleuchte 2 x 40° schwenkbar
- Philips Chip Fortimo SLM Gen.7
- Material Aluminiumdruckguss, Einbaurahmen aus Stahlblech
- Pulverbeschichtet in weiß, schwarz, silber sowie RAL auf Anfrage
- Reflektoren aus 99,9 % Reinstaluminium wahlweise 14, 24 oder 36°
- Bajonettfrontring mit klarem Schutzglas für werkzeuglosen Reflektorwechsel, das Schutzglas schützt Chip und Reflektor vor Verunreinigungen
- Passive Kühlung
- Inkl. Standardtreiber, dimmbare Treiber auf Anfrage
- Gewicht 1,35 kg



- Gimballed recessed LED-luminaire, 2 x 40°
- Philips Chip Fortimo SLM Gen.7
- Material diecast-aluminium, frame out of steel
- Powderpainted in white, black, silver as well as RAL upon demand
- Reflectors out of pure aluminium 99,9 % optionally 14, 24 or 36°
- Twist & look frontring for change of glass & reflectors without any tools, the clear glass protects chip & reflector from dust & dirt
- Passive cooling
- Incl. standard driver, dimmable version upon demand
- Weight: 1,35 kg

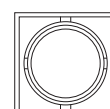

 **150 x 150 mm**

 **140 x 140 mm**

 **160 mm**

  **CE IP 20** 220 - 240 V  
50 - 60 Hz



RAL 9006  
silber/  
silver



RAL 9005  
schwarz/  
black



RAL 9016  
weiß/  
white

## Fortimo SLM Gen.7 LES 19mm 11,2-30,2 W

830	3.000 K	RA 80	1.990 - 4.610 Lumen
835	3.500 K	RA 80	1.910 - 4.620 Lumen
840	4.000 K	RA 80	2.130 - 5.150 Lumen
927	2.700 K	RA 90	1.630 - 3.940 Lumen
930	3.000 K	RA 90	1.710 - 4.130 Lumen
935	3.500 K	RA 90	1.780 - 4.310 Lumen
940	4.000 K	RA 90	1.840 - 4.450 Lumen

## Fortimo SLM Gen.7 FOOD LES 19mm 11,2-30,2 W WARM WHITE

925	2.700 K	RA 90	1.130 - 2.710 Lumen
-----	---------	-------	---------------------

## Fortimo SLM Gen.7 FOOD LES 19mm 11,2-30,2 W PREMIUM RED

930	2.900 K	RA 87	1.180 - 2.820 Lumen
-----	---------	-------	---------------------



**3221**

14° 3221-\_-14

24° 3221-\_-24

36° 3221-\_-36

# DOROX

- Kardanische LED-Einbauleuchte 2 x 40° schwenkbar
- Philips Chip Fortimo SLM Gen.7
- Material Aluminiumdruckguss, Einbaurahmen aus Stahlblech
- Pulverbeschichtet in weiß, schwarz, silber sowie RAL auf Anfrage
- Reflektoren aus 99,9 % Reinaluminium wahlweise 14, 24 oder 36°
- Bajonettfrontring mit klarem Schutzglas für werkzeuglosen Reflektorwechsel, das Schutzglas schützt Chip und Reflektor vor Verunreinigungen
- Passive Kühlung
- Inkl. Standardtreiber, dimmbare Treiber auf Anfrage
- Gewicht: 2,70 kg



- Gimballed recessed LED-luminaire, 2 x 40°
- Philips Chip Fortimo SLM Gen.7
- Material diecast-aluminium, frame out of steel
- Powderpainted in white, black, silver as well as RAL upon demand
- Reflectors out of pure aluminium 99,9 % optionally 14, 24 or 36°
- Twist & look frontring for change of glass & reflectors without any tools, the clear glass protects chip & reflector from dust & dirt
- Passive cooling
- Incl. standard driver, dimmable version upon demand
- Weight: 2,70 kg

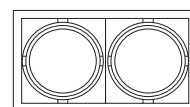

 **150 x 273 mm**

 **140 x 255 mm**

 **160 mm**

  **CE IP 20** 220 - 240 V  
50 - 60 Hz



RAL 9006  
silber/  
silver



RAL 9005  
schwarz/  
black



RAL 9016  
weiß/  
white

## Fortimo SLM Gen.7 LES 19mm 11,2-30,2 W

830	3.000 K	RA 80	1.990 - 4.610 Lumen
835	3.500 K	RA 80	1.910 - 4.620 Lumen
840	4.000 K	RA 80	2.130 - 5.150 Lumen
927	2.700 K	RA 90	1.630 - 3.940 Lumen
930	3.000 K	RA 90	1.710 - 4.130 Lumen
935	3.500 K	RA 90	1.780 - 4.310 Lumen
940	4.000 K	RA 90	1.840 - 4.450 Lumen

## Fortimo SLM Gen.7 FOOD LES 19mm 11,2-30,2 W WARM WHITE

925	2.700 K	RA 90	1.130 - 2.710 Lumen
-----	---------	-------	---------------------

## Fortimo SLM Gen.7 FOOD LES 19mm 11,2-30,2 W PREMIUM RED

930	2.900 K	RA 87	1.180 - 2.820 Lumen
-----	---------	-------	---------------------



**3222**

14° 3222-\_-14

24° 3222-\_-24

36° 3222-\_-36

# PAVO

- Kardanische LED-Einbauleuchte 2 x 40° schwenkbar
- Philips Chip Fortimo SLM Gen.7
- Material Aluminiumdruckguss, Einbaurahmen aus Stahlblech
- Pulverbeschichtet in weiß, schwarz, silber sowie RAL auf Anfrage
- Reflektoren aus 99,9 % Reinstaluminium wahlweise 14, 24, 36 oder 60°
- Bajonettfrontring mit klarem Schutzglas für werkzeuglosen Reflektorwechsel, das Schutzglas schützt Chip und Reflektor vor Verunreinigungen
- Passive Kühlung
- Inkl. Standardtreiber, dimmbare Treiber auf Anfrage
- Gewicht: 1,65 kg



- Gimballed recessed LED-luminaire, 2 x 40°
- Philips Chip Fortimo SLM Gen.7
- Material diecast-aluminium, frame out of steel
- Powderpainted in white, black, silver as well as RAL upon demand
- Reflectors out of pure aluminium 99,9 % optionally 14, 24, 36 or 60°
- Twist & look frontring for change of glass & reflectors without any tools, the clear glass protects chip & reflector from dust & dirt
- Passive cooling
- Incl. standard driver, dimmable version upon demand
- Weight: 1,65 kg

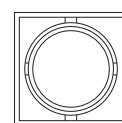

**200 x 200 mm**



**180 x 180 mm**



**150 mm**



**CE IP 20**

220 - 240 V  
50 - 60 Hz



RAL 9006  
silber/  
silver



RAL 9005  
schwarz/  
black



RAL 9016  
weiß/  
white

## Fortimo SLM Gen.7 LES 19mm 11,2-41,7 W

830	3.000 K	RA 80	1.990 - 5.870 Lumen
835	3.500 K	RA 80	1.910 - 5.880 Lumen
840	4.000 K	RA 80	2.130 - 6.620 Lumen
927	2.700 K	RA 90	1.630 - 5.060 Lumen
930	3.000 K	RA 90	1.710 - 5.300 Lumen
935	3.500 K	RA 90	1.780 - 5.530 Lumen
940	4.000 K	RA 90	1.840 - 5.710 Lumen

## Fortimo SLM Gen.7 FOOD LES 19mm 11,2-41,7 W WARM WHITE

925	2.700 K	RA 90	1.130 - 3.460 Lumen
-----	---------	-------	---------------------

## Fortimo SLM Gen.7 FOOD LES 19mm 11,2-41,7 W PREMIUM RED

930	2.900 K	RA 87	1.180 - 3.610 Lumen
-----	---------	-------	---------------------



**3291**

14° 3291-\_-14

24° 3291-\_-24

36° 3291-\_-36

60° 3291-\_-60



# PAVO

- Kardanische LED-Einbauleuchte 2 x 40° schwenkbar
- Philips Chip Fortimo SLM Gen.7
- Material Aluminiumdruckguss, Einbaurahmen aus Stahlblech
- Pulverbeschichtet in weiß, schwarz, silber sowie RAL auf Anfrage
- Reflektoren aus 99,9 % Reinstaluminium wahlweise 14, 24, 36 oder 60°
- Bajonettfrontring mit klarem Schutzglas für werkzeuglosen Reflektorwechsel, das Schutzglas schützt Chip und Reflektor vor Verunreinigungen
- Passive Kühlung
- Inkl. Standardtreiber, dimmbare Treiber auf Anfrage
- Gewicht: 3,15 kg

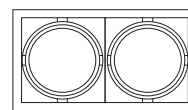

- Gimballed recessed LED-luminaire, 2 x 40°
- Philips Chip Fortimo SLM Gen.7
- Material diecast-aluminium, frame out of steel
- Powderpainted in white, black, silver as well as RAL upon demand
- Reflectors out of pure aluminium 99,9 % optionally 14, 24, 36 or 60°
- Twist & look frontring for change of glass & reflectors without any tools, the clear glass protects chip & reflector from dust & dirt
- Passive cooling
- Incl. standard driver, dimmable version upon demand
- Weight: 3,15 kg



 **200 x 365 mm**  
 **180 x 335 mm**  
 **150 mm**



**CE IP 20**
220 - 240 V  
50 - 60 Hz



1  
RAL 9006  
silber/  
silver



2  
RAL 9005  
schwarz/  
black



3  
RAL 9016  
weiß/  
white

## Fortimo SLM Gen.7 LES 19mm 11,2-41,7 W

830	3.000 K	RA 80	1.990 - 5.870 Lumen
835	3.500 K	RA 80	1.910 - 5.880 Lumen
840	4.000 K	RA 80	2.130 - 6.620 Lumen
927	2.700 K	RA 90	1.630 - 5.060 Lumen
930	3.000 K	RA 90	1.710 - 5.300 Lumen
935	3.500 K	RA 90	1.780 - 5.530 Lumen
940	4.000 K	RA 90	1.840 - 5.710 Lumen

## Fortimo SLM Gen.7 FOOD LES 19mm 11,2-41,7 W WARM WHITE

925	2.700 K	RA 90	1.130 - 3.460 Lumen
-----	---------	-------	---------------------

## Fortimo SLM Gen.7 FOOD LES 19mm 11,2-41,7 W PREMIUM RED

930	2.900 K	RA 87	1.180 - 3.610 Lumen
-----	---------	-------	---------------------



**3292**

14° 3292-\_-14

24° 3292-\_-24



36° 3292-\_-36

60° 3292-\_-60

# PAVO

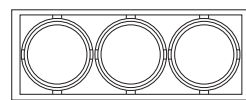
- Kardanische LED-Einbauleuchte 2 x 40° schwenkbar
- Philips Chip Fortimo SLM Gen.7
- Material Aluminiumdruckguss, Einbaurahmen aus Stahlblech
- Pulverbeschichtet in weiß, schwarz, silber sowie RAL auf Anfrage
- Reflektoren aus 99,9 % Reinstaluminium wahlweise 14, 24, 36 oder 60°
- Bajonettfrontring mit klarem Schutzglas für werkzeuglosen Reflektorwechsel, das Schutzglas schützt Chip und Reflektor vor Verunreinigungen
- Passive Kühlung
- Inkl. Standardtreiber, dimmbare Treiber auf Anfrage
- Gewicht: 4,70 kg



 **200 x 530 mm**  
 **180 x 500 mm**  
 **150 mm**

- Gimballed recessed LED-luminaire, 2 x 40°
- Philips Chip Fortimo SLM Gen.7
- Material diecast-aluminium, frame out of steel
- Powderpainted in white, black, silver as well as RAL upon demand
- Reflectors out of pure aluminium 99,9 % optionally 14, 24, 36 or 60°
- Twist & look frontring for change of glass & reflectors without any tools, the clear glass protects chip & reflector from dust & dirt
- Passive cooling
- Incl. standard driver, dimmable version upon demand
- Weight: 4,70 kg



**CE IP 20**
220 - 240 V  
50 - 60 Hz



RAL 9006  
silber/  
silver



RAL 9005  
schwarz/  
black



RAL 9016  
weiß/  
white

## Fortimo SLM Gen.7 LES 19mm 11,2-41,7 W

830	3.000 K	RA 80	1.990 - 5.870 Lumen
835	3.500 K	RA 80	1.910 - 5.880 Lumen
840	4.000 K	RA 80	2.130 - 6.620 Lumen
927	2.700 K	RA 90	1.630 - 5.060 Lumen
930	3.000 K	RA 90	1.710 - 5.300 Lumen
935	3.500 K	RA 90	1.780 - 5.530 Lumen
940	4.000 K	RA 90	1.840 - 5.710 Lumen

## Fortimo SLM Gen.7 FOOD LES 19mm 11,2-41,7 W WARM WHITE

925	2.700 K	RA 90	1.130 - 3.460 Lumen
-----	---------	-------	---------------------

## Fortimo SLM Gen.7 FOOD LES 19mm 11,2-41,7 W PREMIUM RED

930	2.900 K	RA 87	1.180 - 3.610 Lumen
-----	---------	-------	---------------------



**3293**

14° 3293-\_-14

24° 3293-\_-24

36° 3293-\_-36

60° 3293-\_-60

# PAVO

- Kardanische LED-Einbauleuchte 2 x 40° schwenkbar
- Philips Chip Fortimo SLM Gen.7
- Material Aluminiumdruckguss, Einbaurahmen aus Stahlblech
- Pulverbeschichtet in weiß, schwarz, silber sowie RAL auf Anfrage
- Reflektoren aus 99,9 % Reinstaluminium wahlweise 14, 24, 36 oder 60°
- Bajonettfrontring mit klarem Schutzglas für werkzeuglosen Reflektorwechsel, das Schutzglas schützt Chip und Reflektor vor Verunreinigungen
- Passive Kühlung
- Inkl. Standardtreiber, dimmbare Treiber auf Anfrage
- Gewicht: 1,35 kg



- Gimballted recessed LED-luminaire, 2 x 40°
- Philips Chip Fortimo SLM Gen.7
- Material diecast-aluminium, frame out of steel
- Powderpainted in white, black, silver as well as RAL upon demand
- Reflectors out of pure aluminium 99,9 % optionally 14, 24, 36 or 60°
- Twist & look frontring for change of glass & reflectors without any tools, the clear glass protects chip & reflector from dust & dirt
- Passive cooling
- Incl. standard driver, dimmable version upon demand
- Weight: 1,35 kg

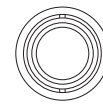

**193 mm**



**180 mm**



**150 mm**



**CE IP 20**

220 - 240 V  
50 - 60 Hz



RAL 9006  
silber/  
silver



RAL 9005  
schwarz/  
black



RAL 9016  
weiß/  
white

## Fortimo SLM Gen.7 LES 19mm 11,2-41,7 W

830	3.000 K	RA 80	1.990 - 5.870 Lumen
835	3.500 K	RA 80	1.910 - 5.880 Lumen
840	4.000 K	RA 80	2.130 - 6.620 Lumen
927	2.700 K	RA 90	1.630 - 5.060 Lumen
930	3.000 K	RA 90	1.710 - 5.300 Lumen
935	3.500 K	RA 90	1.780 - 5.530 Lumen
940	4.000 K	RA 90	1.840 - 5.710 Lumen

## Fortimo SLM Gen.7 FOOD LES 19mm 11,2-41,7 W WARM WHITE

925	2.700 K	RA 90	1.130 - 3.460 Lumen
-----	---------	-------	---------------------

## Fortimo SLM Gen.7 FOOD LES 19mm 11,2-41,7 W PREMIUM RED

930	2.900 K	RA 87	1.180 - 3.610 Lumen
-----	---------	-------	---------------------



**3299**

14° 3299-\_-14

24° 3299-\_-24

36° 3299-\_-36

60° 3299-\_-60

# PAVO

- Kardanische LED-Einbauleuchte 2 x 40° schwenkbar
- Philips Chip Fortimo SLM Gen.7
- Material Aluminiumdruckguss, Einbaurahmen aus Stahlblech
- Pulverbeschichtet in weiß, schwarz, silber sowie RAL auf Anfrage
- Reflektoren aus 99,9 % Reinstaluminium wahlweise 14, 24, 36 oder 60°
- Bajonettfrontring mit klarem Schutzglas für werkzeuglosen Reflektorwechsel, das Schutzglas schützt Chip und Reflektor vor Verunreinigungen
- Passive Kühlung
- Inkl. Standardtreiber, dimmbare Treiber auf Anfrage
- Gewicht: 2,60 kg

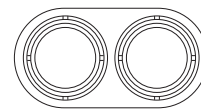
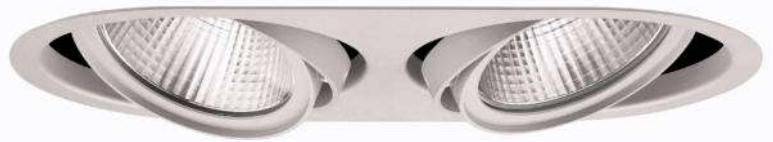

Ø **193 x 375 mm**

⊕ **175 x 355 mm**

↕ **150 mm**

- Gimballed recessed LED-luminaire, 2 x 40°
- Philips Chip Fortimo SLM Gen.7
- Material diecast-aluminium, frame out of steel
- Powderpainted in white, black, silver as well as RAL upon demand
- Reflectors out of pure aluminium 99,9 % optionally 14, 24, 36 or 60°
- Twist & look frontring for change of glass & reflectors without any tools, the clear glass protects chip & reflector from dust & dirt
- Passive cooling
- Incl. standard driver, dimmable version upon demand
- Weight: 2,60 kg

⚠ □ CE IP 20

220 - 240 V  
50 - 60 Hz



1  
RAL 9006  
silber/  
silver



2  
RAL 9005  
schwarz/  
black



3  
RAL 9016  
weiß/  
white

## Fortimo SLM Gen.7 LES 19mm 11,2-41,7 W

830	3.000 K	RA 80	1.990 - 5.870 Lumen
835	3.500 K	RA 80	1.910 - 5.880 Lumen
840	4.000 K	RA 80	2.130 - 6.620 Lumen
927	2.700 K	RA 90	1.630 - 5.060 Lumen
930	3.000 K	RA 90	1.710 - 5.300 Lumen
935	3.500 K	RA 90	1.780 - 5.530 Lumen
940	4.000 K	RA 90	1.840 - 5.710 Lumen

## Fortimo SLM Gen.7 FOOD LES 19mm 11,2-41,7 W WARM WHITE

925	2.700 K	RA 90	1.130 - 3.460 Lumen
-----	---------	-------	---------------------

## Fortimo SLM Gen.7 FOOD LES 19mm 11,2-41,7 W PREMIUM RED

930	2.900 K	RA 87	1.180 - 3.610 Lumen
-----	---------	-------	---------------------



**3282**

14° 3282-\_-14

24° 3282-\_-24

36° 3282-\_-36

60° 3282-\_-60







# PAVO

- Kardanische LED-Einbauleuchte 2 x 40° schwenkbar
- Philips Chip Fortimo SLM Gen.7
- Material Aluminiumdruckguss, Einbaurahmen aus Stahlblech
- Pulverbeschichtet in weiß, schwarz, silber sowie RAL auf Anfrage
- Reflektoren aus 99,9 % Reinstaluminium wahlweise 14, 24, 36 oder 60°
- Bajonettfrontring mit klarem Schutzglas für werkzeuglosen Reflektorwechsel, das Schutzglas schützt Chip und Reflektor vor Verunreinigungen
- Passive Kühlung
- Inkl. Standardtreiber, dimmbare Treiber auf Anfrage
- Gewicht: 3,85 kg

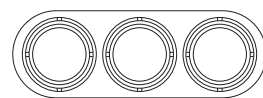

- Gimballed recessed LED-luminaire, 2 x 40°
- Philips Chip Fortimo SLM Gen.7
- Material diecast-aluminium, frame out of steel
- Powderpainted in white, black, silver as well as RAL upon demand
- Reflectors out of pure aluminium 99,9 % optionally 14, 24, 36 or 60°
- Twist & look frontring for change of glass & reflectors without any tools, the clear glass protects chip & reflector from dust & dirt
- Passive cooling
- Incl. standard driver, dimmable version upon demand
- Weight: 3,85 kg



 **193 x 560 mm**  
 **175 x 535 mm**  
 **150 mm**



**CE IP 20**
220 - 240 V  
50 - 60 Hz



1  
RAL 9006  
silber/  
silver



2  
RAL 9005  
schwarz/  
black



3  
RAL 9016  
weiß/  
white

## Fortimo SLM Gen.7 LES 19mm 11,2-41,7 W

830	3.000 K	RA 80	1.990 - 5.870 Lumen
835	3.500 K	RA 80	1.910 - 5.880 Lumen
840	4.000 K	RA 80	2.130 - 6.620 Lumen
927	2.700 K	RA 90	1.630 - 5.060 Lumen
930	3.000 K	RA 90	1.710 - 5.300 Lumen
935	3.500 K	RA 90	1.780 - 5.530 Lumen
940	4.000 K	RA 90	1.840 - 5.710 Lumen

## Fortimo SLM Gen.7 FOOD LES 19mm 11,2-41,7 W WARM WHITE

925	2.700 K	RA 90	1.130 - 3.460 Lumen
-----	---------	-------	---------------------

## Fortimo SLM Gen.7 FOOD LES 19mm 11,2-41,7 W PREMIUM RED

930	2.900 K	RA 87	1.180 - 3.610 Lumen
-----	---------	-------	---------------------



**3283**

14° 3283-\_-14

24° 3283-\_-24

36° 3283-\_-36

60° 3283-\_-60

# PAVO

- LED-Einbauleuchte 350° drehbar und 2 x 40° schwenkbar
- Philips Chip Fortimo SLM Gen.7
- Material Aluminiumdruckguss, Einbaurahmen aus Stahlblech
- Pulverbeschichtet in weiß, schwarz, silber sowie RAL auf Anfrage
- Reflektoren aus 99,9 % Reinstaluminium wahlweise 14, 24, 36 oder 60°
- Bajonettfrontring mit klarem Schutzglas für werkzeuglosen Reflektorwechsel, das Schutzglas schützt Chip und Reflektor vor Verunreinigungen
- Passive Kühlung
- Inkl. Standardtreiber, dimmbare Treiber auf Anfrage
- Gewicht: 1,30 kg



- Recessed LED-luminaire 350° turnable and 2 x 40° adjustable
- Philips Chip Fortimo SLM Gen.7
- Material diecast-aluminium, frame out of steel
- Powderpainted in white, black, silver as well as RAL upon demand
- Reflectors out of pure aluminium 99,9 % optionally 14, 24, 36 or 60°
- Twist & look frontring for change of glass & reflectors without any tools, the clear glass protects chip & reflector from dust & dirt
- Passive cooling
- Incl. standard driver, dimmable version upon demand
- Weight: 1,30 kg

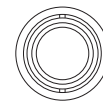

**175 mm**

**160 mm**

**150 mm**



**CE IP 20**

220 - 240 V  
50 - 60 Hz



RAL 9006  
silber/  
silver



RAL 9005  
schwarz/  
black



RAL 9016  
weiß/  
white

## Fortimo SLM Gen.7 LES 19mm 11,2-41,7 W

830	3.000 K	RA 80	1.990 - 5.870 Lumen
835	3.500 K	RA 80	1.910 - 5.880 Lumen
840	4.000 K	RA 80	2.130 - 6.620 Lumen
927	2.700 K	RA 90	1.630 - 5.060 Lumen
930	3.000 K	RA 90	1.710 - 5.300 Lumen
935	3.500 K	RA 90	1.780 - 5.530 Lumen
940	4.000 K	RA 90	1.840 - 5.710 Lumen

## Fortimo SLM Gen.7 FOOD LES 19mm 11,2-41,7 W WARM WHITE

925	2.700 K	RA 90	1.130 - 3.460 Lumen
-----	---------	-------	---------------------

## Fortimo SLM Gen.7 FOOD LES 19mm 11,2-41,7 W PREMIUM RED

930	2.900 K	RA 87	1.180 - 3.610 Lumen
-----	---------	-------	---------------------



**3290**

14° 3290-\_-14

24° 3290-\_-24

36° 3290-\_-36

60° 3290-\_-60

# PAVO

- LED-Einbauleuchte 350° drehbar und 55° ausschwenkbar
- Philips Chip Fortimo SLM Gen.7
- Material Aluminiumdruckguss, Einbaurahmen aus Stahlblech
- Pulverbeschichtet in weiß, schwarz, silber sowie RAL auf Anfrage
- Reflektoren aus 99,9 % Reinstaluminium wahlweise 14, 24, 36 oder 60°
- Bajonettfrontring mit klarem Schutzglas für werkzeuglosen Reflektorwechsel, das Schutzglas schützt Chip und Reflektor vor Verunreinigungen
- Passive Kühlung
- Inkl. Standardtreiber, dimmbare Treiber auf Anfrage
- Gewicht: 1,65 kg



- Recessed LED-luminaire 350° turnable and 55° adjustable
- Philips Chip Fortimo SLM Gen.7
- Material diecast-aluminium, frame out of steel
- Powderpainted in white, black, silver as well as RAL upon demand
- Reflectors out of pure aluminium 99,9 % optionally 14, 24, 36 or 60°
- Twist & look frontring for change of glass & reflectors without any tools, the clear glass protects chip & reflector from dust & dirt
- Passive cooling
- Incl. standard driver, dimmable version upon demand
- Weight: 1,65 kg

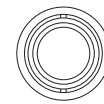

**193 mm**



**180 mm**



**150 mm**



**CE IP 20**

220 - 240 V  
50 - 60 Hz



RAL 9006  
silber/  
silver



RAL 9005  
schwarz/  
black



RAL 9016  
weiß/  
white

## Fortimo SLM Gen.7 LES 19mm 11,2-41,7 W

830	3.000 K	RA 80	1.990 - 5.870 Lumen
835	3.500 K	RA 80	1.910 - 5.880 Lumen
840	4.000 K	RA 80	2.130 - 6.620 Lumen
927	2.700 K	RA 90	1.630 - 5.060 Lumen
930	3.000 K	RA 90	1.710 - 5.300 Lumen
935	3.500 K	RA 90	1.780 - 5.530 Lumen
940	4.000 K	RA 90	1.840 - 5.710 Lumen

## Fortimo SLM Gen.7 FOOD LES 19mm 11,2-41,7 W WARM WHITE

925	2.700 K	RA 90	1.130 - 3.460 Lumen
-----	---------	-------	---------------------

## Fortimo SLM Gen.7 FOOD LES 19mm 11,2-41,7 W PREMIUM RED

930	2.900 K	RA 87	1.180 - 3.610 Lumen
-----	---------	-------	---------------------



**3298**

14° 3298-\_-14

24° 3298-\_-24

36° 3298-\_-36

60° 3298-\_-60