

# PAVO P 2

- Kardanische LED-Pendelleuchte 2 x 40° schwenkbar
- Philips Chip Fortimo SLM Gen.7
- Material Aluminiumdruckguss, Rahmen aus Stahlblech
- Pulverbeschichtet in weiß, schwarz, silber sowie RAL auf Anfrage
- Reflektoren aus 99,9 % Reinaluminium wahlweise 14, 24, 36 oder 60°
- Bajonettfrontring mit klarem Schutzglas für werkzeuglosen Reflektorwechsel, das Schutzglas schützt Chip und Reflektor vor Verunreinigungen
- Passive Kühlung
- Inkl. Standardtreiber, dimmbare Treiber auf Anfrage
- Inkl. 2 x Y-Seilaufhängung 2.000 mm lang
- Gewicht: 3,60 kg

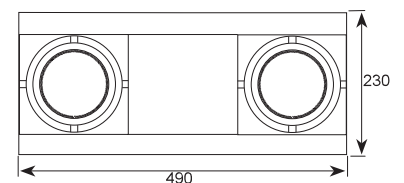

- Gimballed pendant LED-luminaire, 2 x 40°
- Philips Chip Fortimo SLM Gen.7
- Material diecast-aluminium, frame out of steel
- Powderpainted in white, black, silver as well as RAL upon demand
- Reflectors out of pure aluminium 99,9 % optionally 14, 24, 36 or 60°
- Twist & look frontring for change of glass & reflectors without any tools, the clear glass protects chip & reflector from dust & dirt
- Passive cooling
- Incl. standard driver, dimmable version upon demand
- Incl. 2 x Y-wire-suspension 2.000 mm
- Weight: 3,60 kg



**CE IP 20**
220 - 240 V  
50 - 60 Hz



RAL 9006  
silber/  
silver



RAL 9005  
schwarz/  
black



RAL 9016  
weiß/  
white

## Fortimo SLM Gen.7 LES 19mm 11,2-41,7 W

|     |         |       |                     |
|-----|---------|-------|---------------------|
| 830 | 3.000 K | RA 80 | 1.990 - 5.870 Lumen |
| 835 | 3.500 K | RA 80 | 1.910 - 5.880 Lumen |
| 840 | 4.000 K | RA 80 | 2.130 - 6.620 Lumen |
| 927 | 2.700 K | RA 90 | 1.630 - 5.060 Lumen |
| 930 | 3.000 K | RA 90 | 1.710 - 5.300 Lumen |
| 935 | 3.500 K | RA 90 | 1.780 - 5.530 Lumen |
| 940 | 4.000 K | RA 90 | 1.840 - 5.710 Lumen |

## Fortimo SLM Gen.7 FOOD LES 19mm 11,2-41,7 W WARM WHITE

|     |         |       |                     |
|-----|---------|-------|---------------------|
| 925 | 2.700 K | RA 90 | 1.130 - 3.460 Lumen |
|-----|---------|-------|---------------------|

## Fortimo SLM Gen.7 FOOD LES 19mm 11,2-41,7 W PREMIUM RED

|     |         |       |                     |
|-----|---------|-------|---------------------|
| 930 | 2.900 K | RA 87 | 1.180 - 3.610 Lumen |
|-----|---------|-------|---------------------|



**6232**

14° 6232-\_-14

24° 6232-\_-24

36° 6232-\_-36

60° 6232-\_-60

# PAVO P 4

- Kardanische LED-Pendelleuchte 2 x 40° schwenkbar
  - Philips Chip Fortimo SLM Gen.7
  - Material Aluminiumdruckguss, Rahmen aus Stahlblech
  - Pulverbeschichtet in weiß, schwarz, silber sowie RAL auf Anfrage
  - Reflektoren aus 99,9 % Reinaluminium wahlweise 14, 24, 36 oder 60°
  - Bajonettfrontring mit klarem Schutzglas für werkzeuglosen Reflektorwechsel, das Schutzglas schützt Chip und Reflektor vor Verunreinigungen
  - Passive Kühlung
  - Inkl. Standardtreiber, dimmbare Treiber auf Anfrage
  - Inkl. 2 x Y-Seilaufhängung 2.000 mm lang
  - Gewicht: 6,90 kg
- 
- Gimballed pendant LED-luminaire, 2 x 40°
  - Philips Chip Fortimo SLM Gen.7
  - Material diecast-aluminium, frame out of steel
  - Powderpainted in white, black, silver as well as RAL upon demand
  - Reflectors out of pure aluminium 99,9 % optionally 14, 24, 36 or 60°
  - Twist & look frontring for change of glass & reflectors without any tools, the clear glass protects chip & reflector from dust & dirt
  - Passive cooling
  - Incl. standard driver, dimmable version upon demand
  - Incl. 2 x Y-wire-suspension 2.000 mm
  - Weight: 6,90 kg

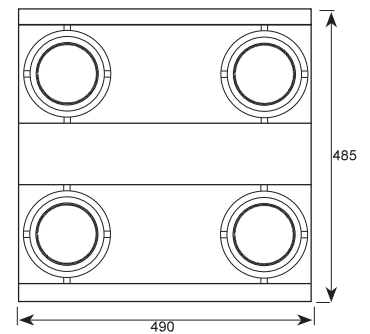



**CE IP 20**
220 - 240 V  
50 - 60 Hz



RAL 9006  
silber/  
silver



RAL 9005  
schwarz/  
black



RAL 9016  
weiß/  
white

## Fortimo SLM Gen.7 LES 19mm 11,2-41,7 W

|     |         |       |                     |
|-----|---------|-------|---------------------|
| 830 | 3.000 K | RA 80 | 1.990 - 5.870 Lumen |
| 835 | 3.500 K | RA 80 | 1.910 - 5.880 Lumen |
| 840 | 4.000 K | RA 80 | 2.130 - 6.620 Lumen |
| 927 | 2.700 K | RA 90 | 1.630 - 5.060 Lumen |
| 930 | 3.000 K | RA 90 | 1.710 - 5.300 Lumen |
| 935 | 3.500 K | RA 90 | 1.780 - 5.530 Lumen |
| 940 | 4.000 K | RA 90 | 1.840 - 5.710 Lumen |

## Fortimo SLM Gen.7 FOOD LES 19mm 11,2-41,7 W WARM WHITE

|     |         |       |                     |
|-----|---------|-------|---------------------|
| 925 | 2.700 K | RA 90 | 1.130 - 3.460 Lumen |
|-----|---------|-------|---------------------|

## Fortimo SLM Gen.7 FOOD LES 19mm 11,2-41,7 W PREMIUM RED

|     |         |       |                     |
|-----|---------|-------|---------------------|
| 930 | 2.900 K | RA 87 | 1.180 - 3.610 Lumen |
|-----|---------|-------|---------------------|



**6242**

14° 6242-\_-14

24° 6242-\_-24

36° 6242-\_-36

60° 6242-\_-60

# PAVO P 3

- Kardanische LED-Pendelleuchte 2 x 40° schwenkbar
- Philips Chip Fortimo SLM Gen.7
- Material Aluminiumdruckguss, Rahmen aus Stahlblech
- Pulverbeschichtet in weiß, schwarz, silber sowie RAL auf Anfrage
- Reflektoren aus 99,9 % Reinstaluminium wahlweise 14, 24, 36 oder 60°
- Bajonettfrontring mit klarem Schutzglas für werkzeuglosen Reflektorwechsel, das Schutzglas schützt Chip und Reflektor vor Verunreinigungen
- Passive Kühlung
- Inkl. Standardtreiber, dimmbare Treiber auf Anfrage
- Inkl. 2 x Y-Seilaufhängung 2.000 mm lang
- Gewicht: 4,90 kg

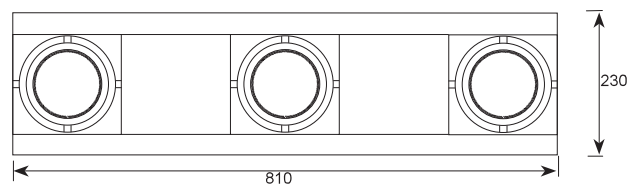

- Gimballed pendant LED-luminaire, 2 x 40°
- Philips Chip Fortimo SLM Gen.7
- Material diecast-aluminium, frame out of steel
- Powderpainted in white, black, silver as well as RAL upon demand
- Reflectors out of pure aluminium 99,9 % optionally 14, 24, 36 or 60°
- Twist & look frontring for change of glass & reflectors without any tools, the clear glass protects chip & reflector from dust & dirt
- Passive cooling
- Incl. standard driver, dimmable version upon demand
- Incl. 2 x Y-wire-suspension 2.000 mm
- Weight: 4,90 kg



**CE IP 20**
220 - 240 V  
50 - 60 Hz



1  
RAL 9006  
silber/  
silver



2  
RAL 9005  
schwarz/  
black



3  
RAL 9016  
weiß/  
white

## Fortimo SLM Gen.7 LES 19mm 11,2-41,7 W

|     |         |       |                     |
|-----|---------|-------|---------------------|
| 830 | 3.000 K | RA 80 | 1.990 - 5.870 Lumen |
| 835 | 3.500 K | RA 80 | 1.910 - 5.880 Lumen |
| 840 | 4.000 K | RA 80 | 2.130 - 6.620 Lumen |
| 927 | 2.700 K | RA 90 | 1.630 - 5.060 Lumen |
| 930 | 3.000 K | RA 90 | 1.710 - 5.300 Lumen |
| 935 | 3.500 K | RA 90 | 1.780 - 5.530 Lumen |
| 940 | 4.000 K | RA 90 | 1.840 - 5.710 Lumen |

## Fortimo SLM Gen.7 FOOD LES 19mm 11,2-41,7 W WARM WHITE

|     |         |       |                     |
|-----|---------|-------|---------------------|
| 925 | 2.700 K | RA 90 | 1.130 - 3.460 Lumen |
|-----|---------|-------|---------------------|

## Fortimo SLM Gen.7 FOOD LES 19mm 11,2-41,7 W PREMIUM RED

|     |         |       |                     |
|-----|---------|-------|---------------------|
| 930 | 2.900 K | RA 87 | 1.180 - 3.610 Lumen |
|-----|---------|-------|---------------------|



**6252**

14° 6252-\_-14

24° 6252-\_-24

36° 6252-\_-36

60° 6252-\_-60

# PAVO P 150

- LED-Pendelleuchte 2 x 15° schwenkbar
- Philips Chip Fortimo SLM Gen.7
- Material Aluminium
- Pulverbeschichtet in weiß, schwarz, silber sowie RAL auf Anfrage
- Reflektoren aus 99,9 % Reinaluminium wahlweise 14, 24, 36 oder 60°
- Bajonettfrontring mit klarem Schutzglas für werkzeuglosen Reflektorwechsel, das Schutzglas schützt Chip und Reflektor vor Verunreinigungen
- Passive Kühlung
- Inkl. Standardtreiber, dimmbare Treiber auf Anfrage
- Inkl. Seilaufhängung 2.000 mm
- Gewicht: 2,70 kg

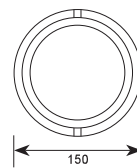
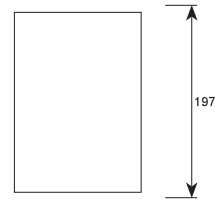

- Pendant LED-luminaire, 2 x 15° adjustable
- Philips Chip Fortimo SLM Gen.7
- Material aluminium
- Powderpainted in white, black, silver as well as RAL upon demand
- Reflectors out of pure aluminium 99,9 % optionally 14, 24, 36 or 60°
- Twist & look frontring for change of glass & reflectors without any tools, the clear glass protects chip & reflector from dust & dirt
- Passive cooling
- Incl. standard driver, dimmable version upon demand
- Incl. wire-suspension 2.000 mm
- Weight: 2,70 kg



CE IP 20

220 - 240 V  
50 - 60 Hz



1  
RAL 9006  
silber/  
silver



2  
RAL 9005  
schwarz/  
black



3  
RAL 9016  
weiß/  
white

## Fortimo SLM Gen.7 LES 19mm 11,2-41,7 W

|     |         |       |                     |
|-----|---------|-------|---------------------|
| 830 | 3.000 K | RA 80 | 1.990 - 5.870 Lumen |
| 835 | 3.500 K | RA 80 | 1.910 - 5.880 Lumen |
| 840 | 4.000 K | RA 80 | 2.130 - 6.620 Lumen |
| 927 | 2.700 K | RA 90 | 1.630 - 5.060 Lumen |
| 930 | 3.000 K | RA 90 | 1.710 - 5.300 Lumen |
| 935 | 3.500 K | RA 90 | 1.780 - 5.530 Lumen |
| 940 | 4.000 K | RA 90 | 1.840 - 5.710 Lumen |

## Fortimo SLM Gen.7 FOOD LES 19mm 11,2-41,7 W WARM WHITE

|     |         |       |                     |
|-----|---------|-------|---------------------|
| 925 | 2.700 K | RA 90 | 1.130 - 3.460 Lumen |
|-----|---------|-------|---------------------|

## Fortimo SLM Gen.7 FOOD LES 19mm 11,2-41,7 W PREMIUM RED

|     |         |       |                     |
|-----|---------|-------|---------------------|
| 930 | 2.900 K | RA 87 | 1.180 - 3.610 Lumen |
|-----|---------|-------|---------------------|



**1269**

14° 1269-\_-14

24° 1269-\_-24

36° 1269-\_-36

60° 1260-\_-60

# PAVO P 237

- Kardanische LED-Pendelleuchte 2 x 40° schwenkbar
- Philips Chip Fortimo SLM Gen.7
- Material Aluminiumdruckguss, Zylinder aus Stahlblech
- Pulverbeschichtet in weiß, schwarz, silber sowie RAL auf Anfrage
- Reflektoren aus 99,9 % Reinaluminium wahlweise 14, 24, 36 oder 60°
- Bajonettfrontring mit klarem Schutzglas für werkzeuglosen Reflektorwechsel, das Schutzglas schützt Chip und Reflektor vor Verunreinigungen
- Passive Kühlung
- Inkl. Standardtreiber, dimmbare Treiber auf Anfrage
- Inkl. Seilaufhängung 2.000 mm
- Gewicht: 3,50 kg

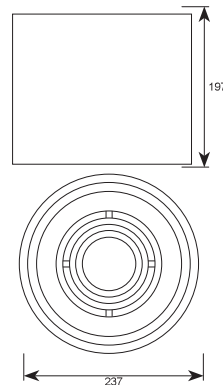

- Gimballed pendant LED-luminaire, 2 x 40°
- Philips Chip Fortimo SLM Gen.7
- Material diecast-aluminium, cylinder out of steel
- Powderpainted in white, black, silver as well as RAL upon demand
- Reflectors out of pure aluminium 99,9 % optionally 14, 24, 36 or 60°
- Twist & look frontring for change of glass & reflectors without any tools, the clear glass protects chip & reflector from dust & dirt
- Passive cooling
- Incl. standard driver, dimmable version upon demand
- Incl. wire-suspension 2.000 mm
- Weight: 3,50 kg



CE IP 20

220 - 240 V  
50 - 60 Hz



1  
RAL 9006  
silber/  
silver



2  
RAL 9005  
schwarz/  
black



3  
RAL 9016  
weiß/  
white

## Fortimo SLM Gen.7 LES 19mm 11,2-41,7 W

|     |         |       |                     |
|-----|---------|-------|---------------------|
| 830 | 3.000 K | RA 80 | 1.990 - 5.870 Lumen |
| 835 | 3.500 K | RA 80 | 1.910 - 5.880 Lumen |
| 840 | 4.000 K | RA 80 | 2.130 - 6.620 Lumen |
| 927 | 2.700 K | RA 90 | 1.630 - 5.060 Lumen |
| 930 | 3.000 K | RA 90 | 1.710 - 5.300 Lumen |
| 935 | 3.500 K | RA 90 | 1.780 - 5.530 Lumen |
| 940 | 4.000 K | RA 90 | 1.840 - 5.710 Lumen |

## Fortimo SLM Gen.7 FOOD LES 19mm 11,2-41,7 W WARM WHITE

|     |         |       |                     |
|-----|---------|-------|---------------------|
| 925 | 2.700 K | RA 90 | 1.130 - 3.460 Lumen |
|-----|---------|-------|---------------------|

## Fortimo SLM Gen.7 FOOD LES 19mm 11,2-41,7 W PREMIUM RED

|     |         |       |                     |
|-----|---------|-------|---------------------|
| 930 | 2.900 K | RA 87 | 1.180 - 3.610 Lumen |
|-----|---------|-------|---------------------|



1289

14° 1289-\_-14

24° 1289-\_-24

36° 1289-\_-36

60° 1289-\_-60

# FACTORY 315

- LED-Pendelleuchte 2 x 15° schwenkbar
- Philips Chip Fortimo SLM Gen.7
- Material Aluminiumdruckguss und Stahlblech
- Pulverbeschichtet in weiß, schwarz, silber sowie RAL auf Anfrage
- Reflektoren aus 99,9 % Reinaluminium wahlweise 14, 24 oder 36°
- Bajonettfrontring mit klarem Schutzglas für werkzeuglosen Reflektorwechsel, das Schutzglas schützt Chip und Reflektor vor Verunreinigungen
- Passive Kühlung
- Inkl. Standardtreiber, dimmbare Treiber auf Anfrage
- Gewicht 2,70 kg

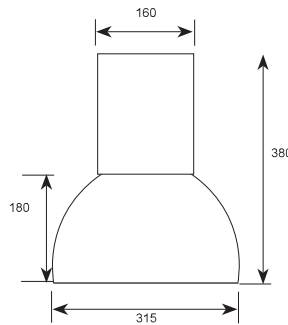

- Pendant LED-luminaire, 2 x 15° adjustable
- Philips Chip Fortimo SLM Gen.7
- Material diecast-aluminium and steel
- Powderpainted in white, black, silver as well as RAL upon demand
- Reflectors out of pure aluminium 99,9 % optionally 14, 24 or 36°
- Twist & look frontring for change of glass & reflectors without any tools, the clear glass protects chip & reflector from dust & dirt
- Passive cooling
- Incl. standard driver, dimmable version upon demand
- Weight: 2,70 kg



220 - 240 V  
50 - 60 Hz



RAL 9006  
silber/  
silver



RAL 9005  
schwarz/  
black



RAL 9016  
weiß/  
white

## Fortimo SLM Gen.7 LES 19mm 11,2-30,2 W

|     |         |       |                     |
|-----|---------|-------|---------------------|
| 830 | 3.000 K | RA 80 | 1.990 - 4.610 Lumen |
| 835 | 3.500 K | RA 80 | 1.910 - 4.620 Lumen |
| 840 | 4.000 K | RA 80 | 2.130 - 5.150 Lumen |
| 927 | 2.700 K | RA 90 | 1.630 - 3.940 Lumen |
| 930 | 3.000 K | RA 90 | 1.710 - 4.130 Lumen |
| 935 | 3.500 K | RA 90 | 1.780 - 4.310 Lumen |
| 940 | 4.000 K | RA 90 | 1.840 - 4.450 Lumen |

## Fortimo SLM Gen.7 FOOD LES 19mm 11,2-30,2 W WARM WHITE

|     |         |       |                     |
|-----|---------|-------|---------------------|
| 925 | 2.700 K | RA 90 | 1.130 - 2.710 Lumen |
|-----|---------|-------|---------------------|

## Fortimo SLM Gen.7 FOOD LES 19mm 11,2-30,2 W PREMIUM RED

|     |         |       |                     |
|-----|---------|-------|---------------------|
| 930 | 2.900 K | RA 87 | 1.180 - 2.820 Lumen |
|-----|---------|-------|---------------------|



## FACTORY 315

|     |           |
|-----|-----------|
| 14° | 1249-_-14 |
| 24° | 1249-_-24 |
| 36° | 1249-_-36 |